

Winter

Smorgasbord

1st
GRADE

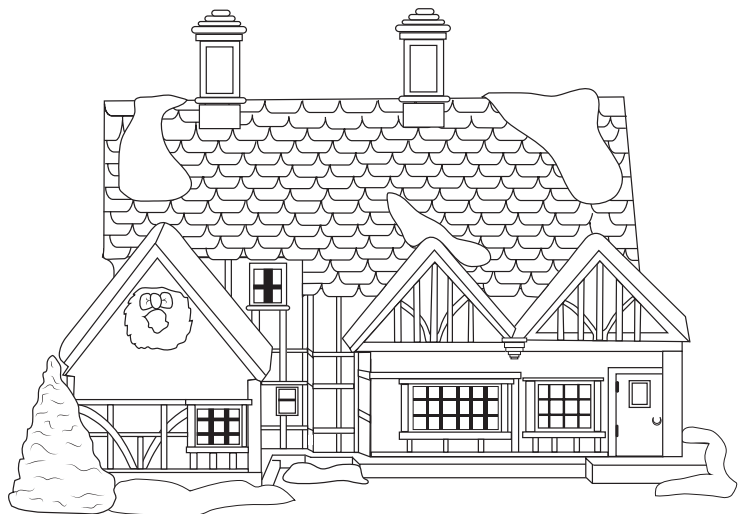
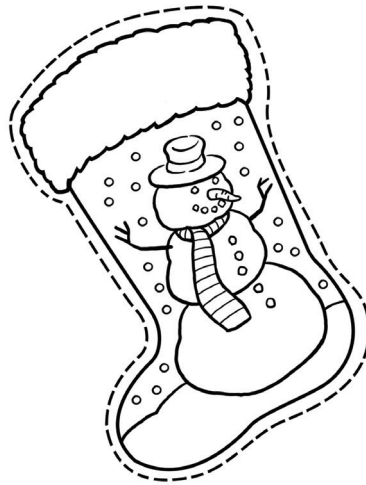

Table of Contents

Winter Smorgasbord

Build a Snowman
Letter to Santa Template
Winter Bucket List
To Do List
Winter Banner!
Acrostic Winter Poem
Snow Globe Coloring Page
Make a Paper Snowflake
Color Christmas Ornaments
Wonderful Winter!
Hot Chocolate Coloring Page
Printable Advent Calendar
Printable Christmas Stocking
Ski Maze
Play Snowman Tic-Tac-Toe
Holiday Card Templates
Christmas Village House
Christmas Village House #2
Christmas Village Gazebo
Christmas Village School
Christmas Village Store
Christmas Village Fountain
New Year's Party Hat
New Year's Resolutions

Certificate of Completion

Want more workbooks? Join [Education.com Plus](http://www.education.com/education-plus/) to save time and money.
<http://www.education.com/education-plus/>

Build a Snowman!

1. Color
2. Cut
3. Paste



Dear **SANTA,**

Happy Holidays again!

I wanted to let you know
the things that I've done

REALLY well this
year :

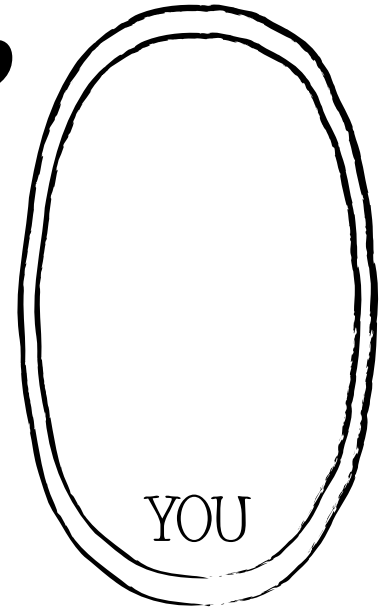

I have a few Christmas **WISHES**

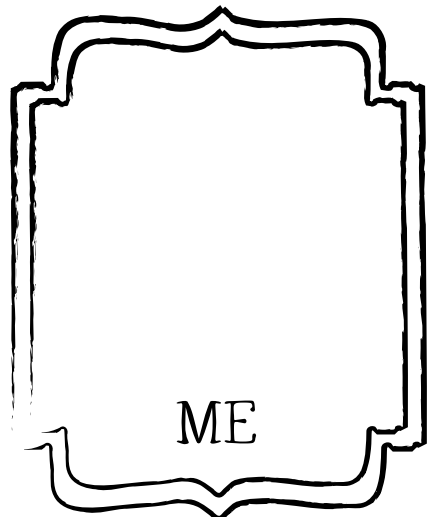

LOVE

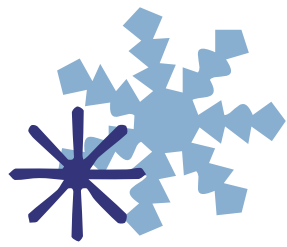

WINTER

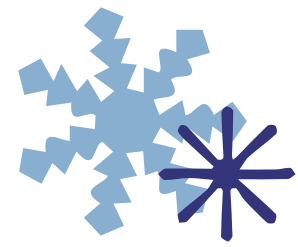

BUCKET LIST

Make a sparkly ornament

Spend a whole day baking cookies

Snuggle up for a holiday movie marathon

LISTEN TO CAROLERS ON YOUR DOORSTEP

Fold and cut out paper snowflakes

Have an icicle sword fight

STAY IN YOUR PJS ALL DAY

Watch a play or musical

Give a "secret" gift to someone

BAKE YOUR FAVORITE COOKIES

Make a snowman

Decorate your house for winter

Breathe onto cold glass and draw a picture

Drink hot cocoa with marshmallows

MAKE HOMEMADE PEPPERMINT BARK

Make a snow angel

Build your own sled run

MAKE INDOOR S'MORES

Sit by the fire and read a good book

Make a gingerbread house

Look at Christmas lights

VOLUNTEER AT A SHELTER

Go ice skating

Cross stitch a picture

Have an indoor picnic with your friends

MAKE CARAMEL CORN

Take pictures in the snow

TO DO LIST

NAME

DATE

TASKS	NOTES
COMPLETED?	



WINTER FUN BANNER!

Make your banner any length by printing as many pages as you like. The more pages, the longer the banner! Use thicker paper for best results.

1 After the pieces have been colored, ask a grown-up to help cut and fold the shapes. You will need string, ribbon or yarn, and some tape.

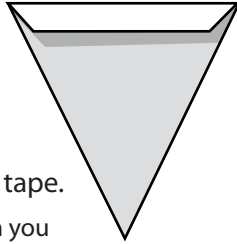

To figure out how much yarn you will need, just line up all the pieces with spaces in between, then measure and add a little extra on each end for tying or taping.

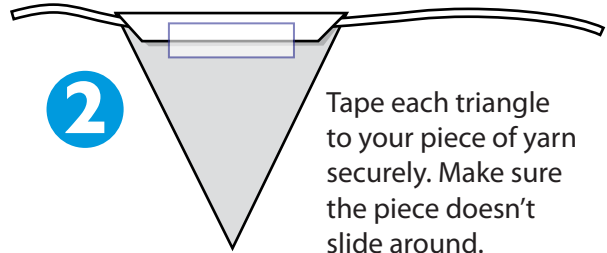

2

Tape each triangle to your piece of yarn securely. Make sure the piece doesn't slide around.

3 Have a grown-up help tape or pin your banner up in your room, across a big window, or anywhere there's space for it!

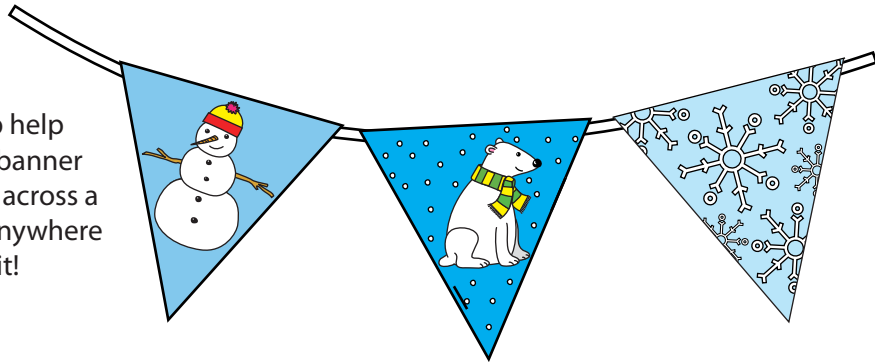

Fold on the dotted lines.

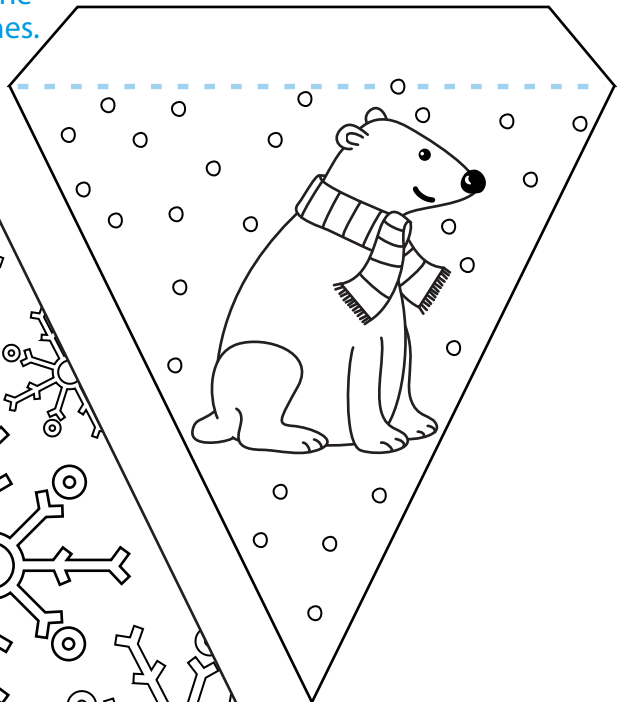
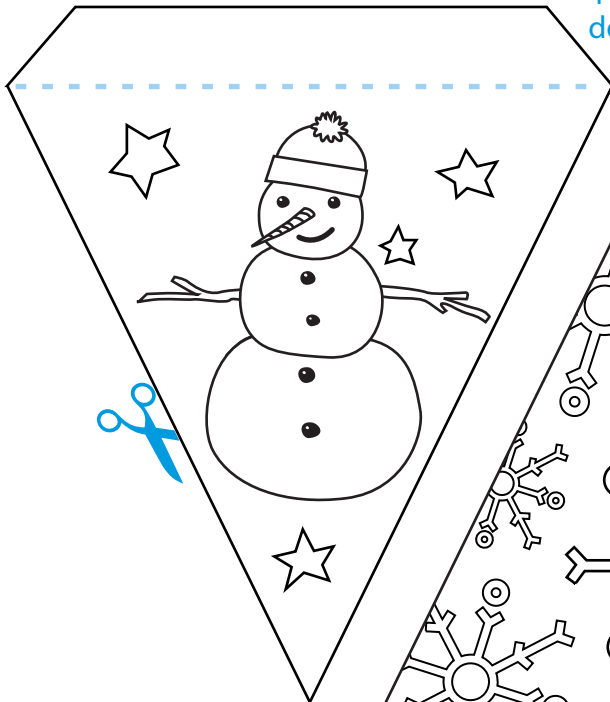

Print on thicker paper for best results.

WINTER FUN BANNER!

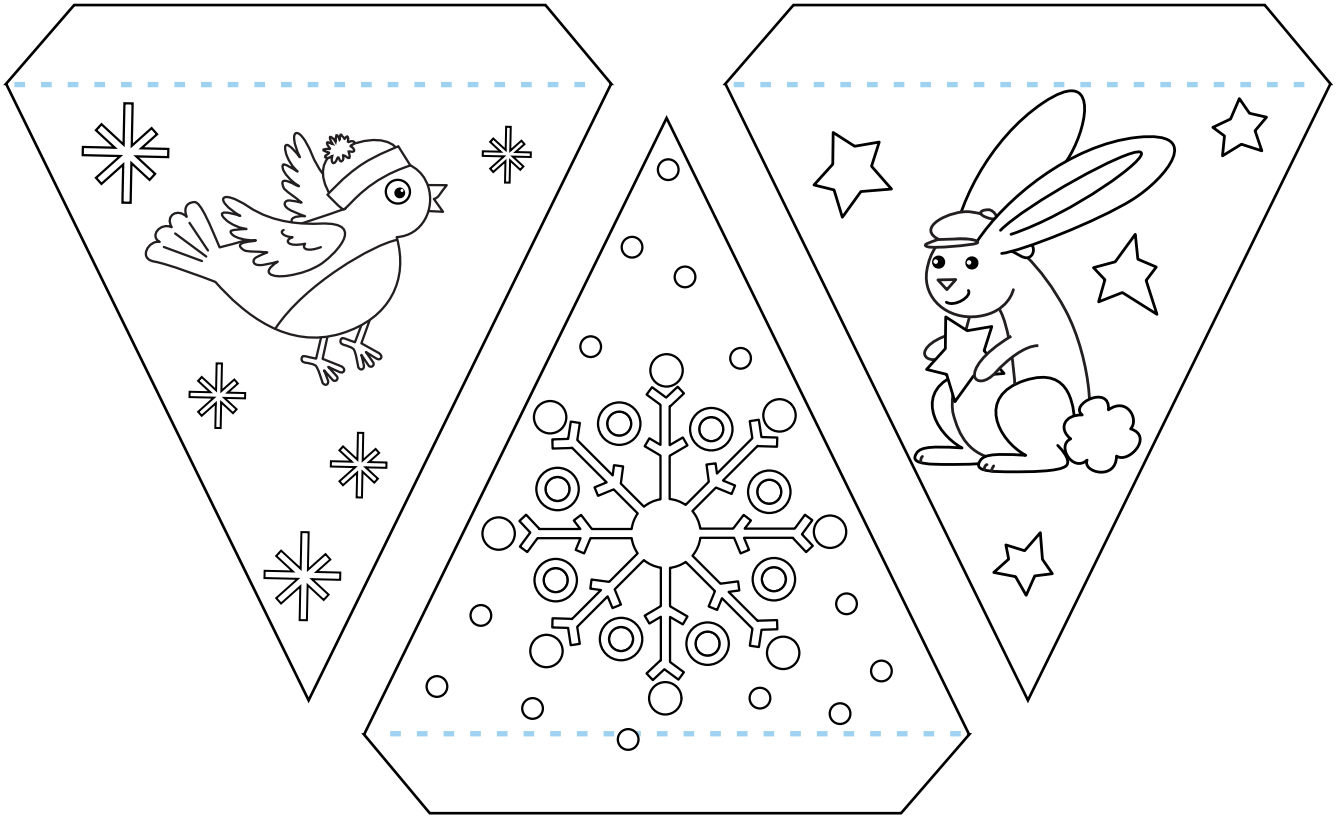

Fold on the
dotted lines.

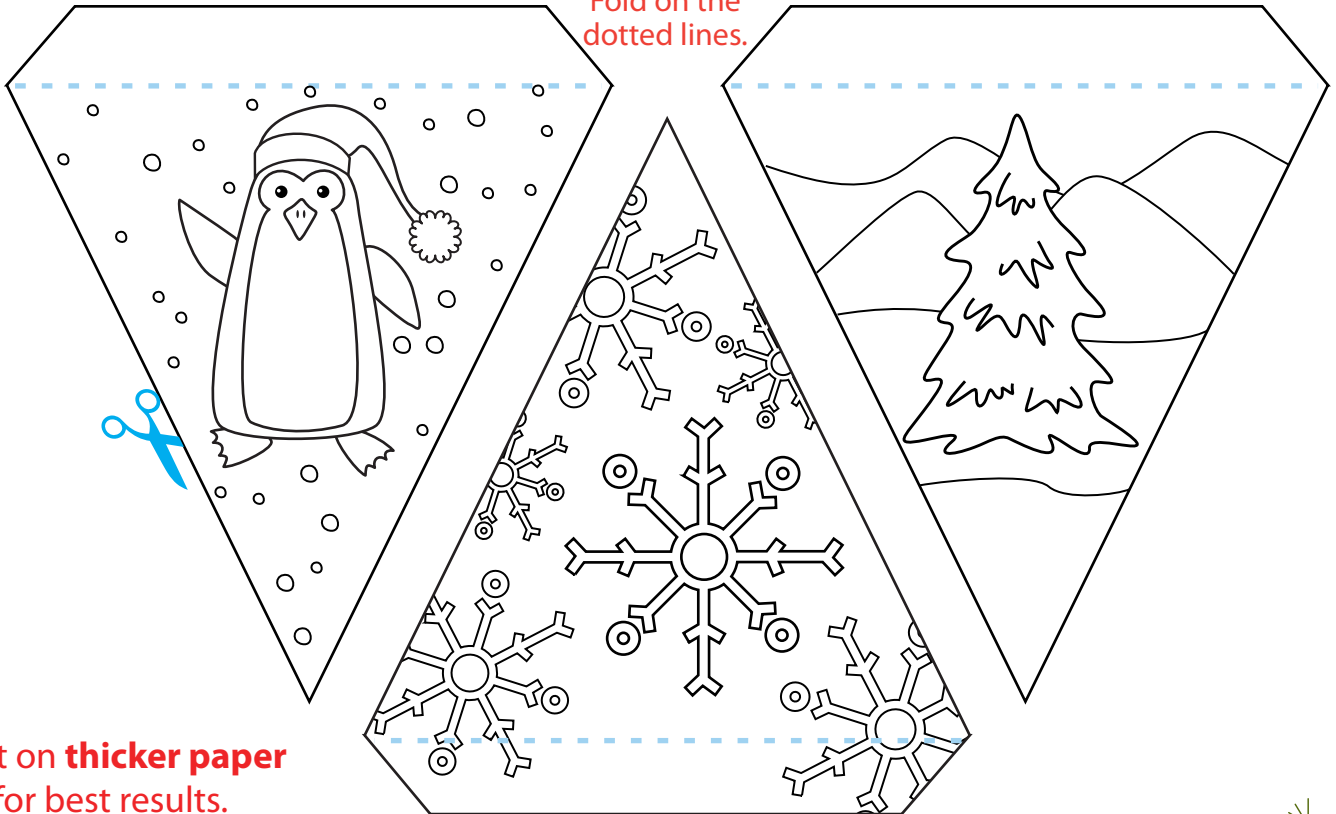

Print on **thicker paper**
for best results.

Write a word that makes you think of
Winter. Start each word with the letters in
the word WINTER.

W

I

N

T

E

R



Make a Paper Snowflake!

Make a pretty snowflake to decorate for the holidays.

1. Carefully cut out the circle.
2. Fold in half along the dotted lines.
3. Fold in half twice more along the lines. Make sure the slice with the small designs is on top.
4. Cut out shapes along the dotted designs.
5. Unfold for a beautiful snowflake!

*Make sure this slice is on top.
Then cut out the shapes.*

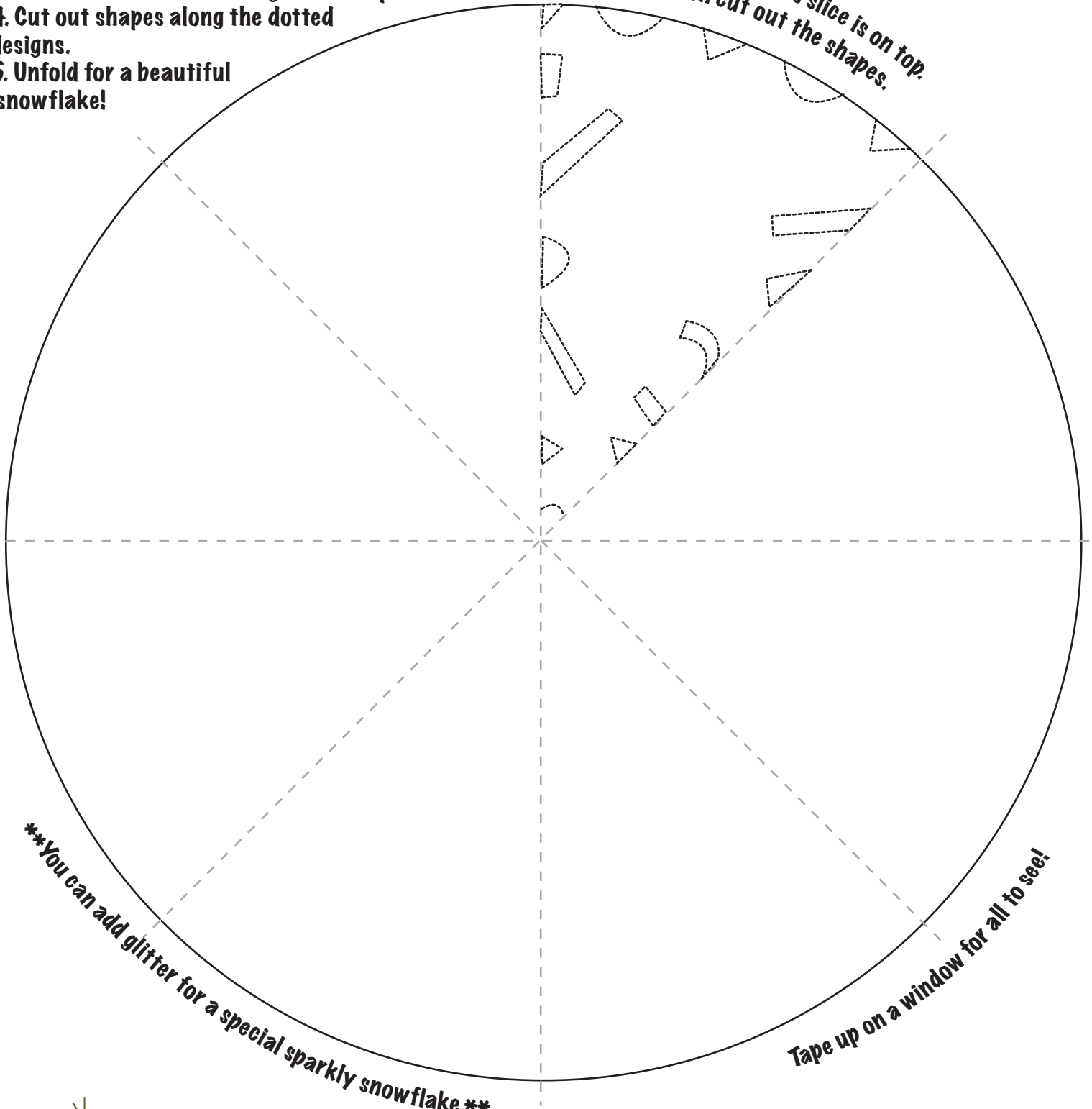

You can add glitter for a special sparkly snowflake.

Tape up on a window for all to see!

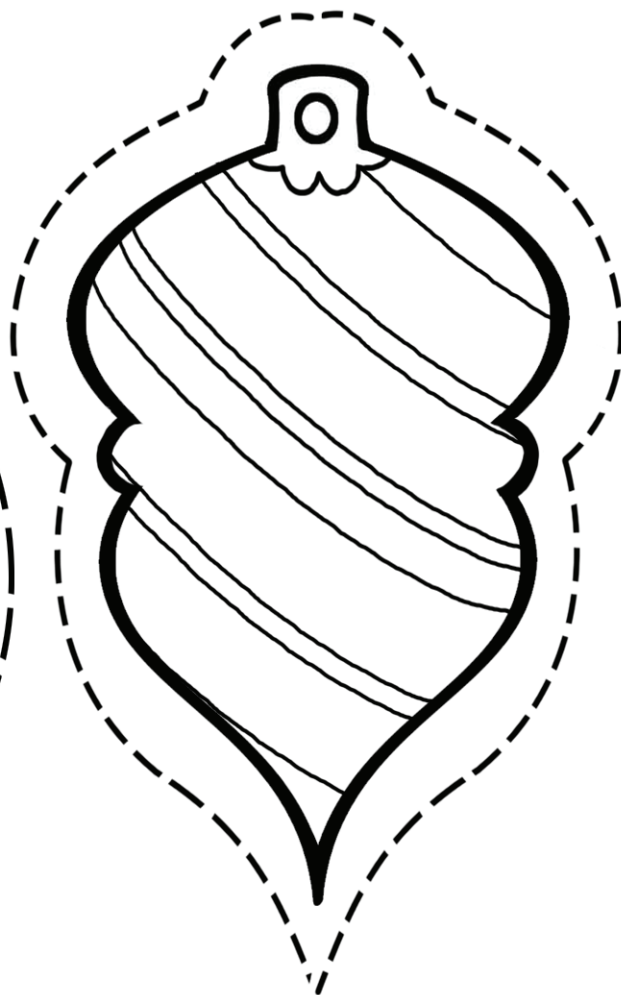
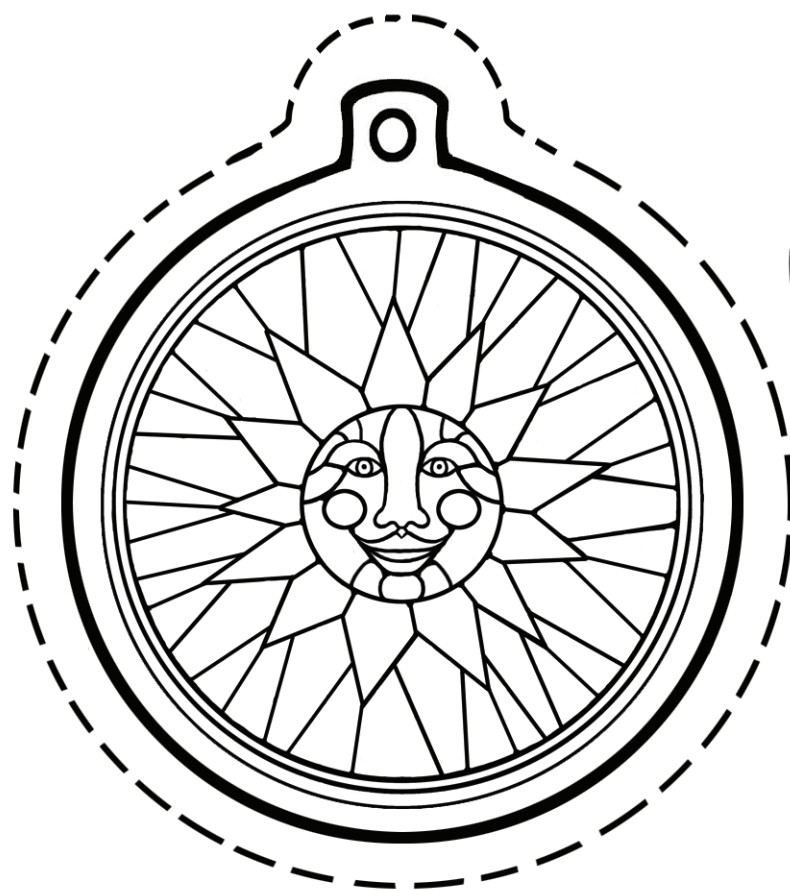
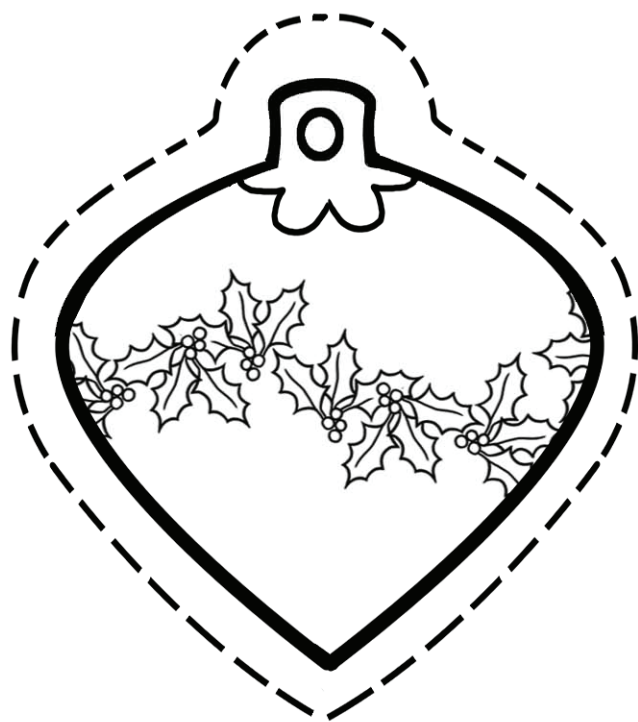

Wonderful Winter!

Can you find all of the snowmen in the illustration below? Hint: There are 27 snowmen in total.

(Including snow-women and snow-kids.)

Bonus Activity: Color in this festive winter wonderland with your favorite colors!



Did you know?
The largest snowman ever
built stood 122 feet 1 inch tall!

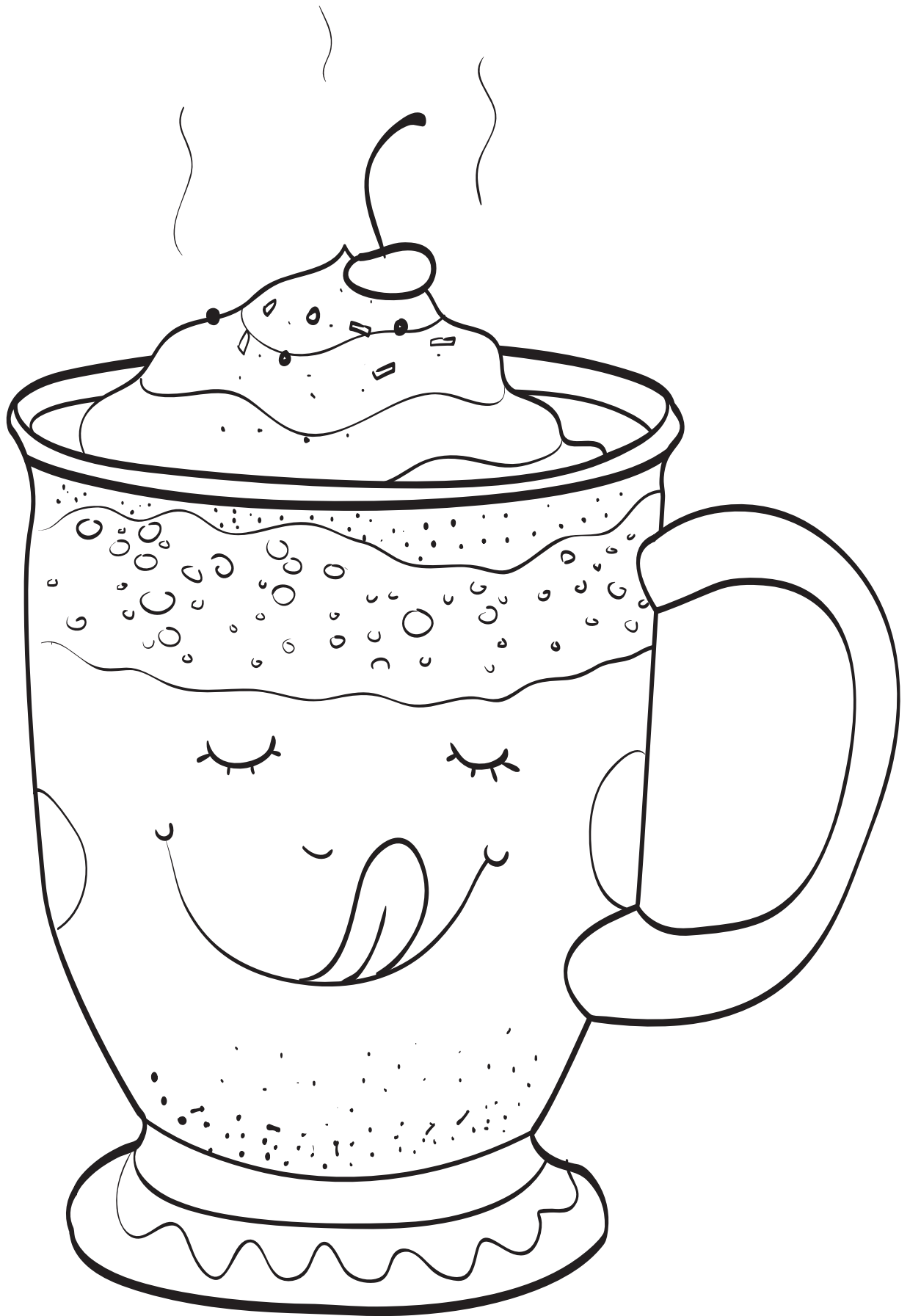



- Cut along the dashed lines on page 1. DO NOT cut the solid lines.
- Tape or glue page 1 to the front of page 2.

Make homemade ornaments using things you find around the house.

Go outside and make a snowman.
(No snow? Use cotton balls to create a snowman)

Measure your Christmas tree!

Add a candy cane to your hot chocolate to make a minty treat.

Build a gingerbread house!

Many Christmas trees are topped with a star, an angel, or even Santa Claus statue.

This Christmas, donate a present to a child who is in need.

Help your parents wrap presents.

Watch your favorite Christmas movie!

Make a homemade holiday card for your teacher.

Combine oatmeal and glitter to create magic Christmas dust.
Sprinkle it on your lawn to help Santa's reindeer find your house.

Don't forget to send your letter to Santa!

Cut out paper snowflakes and hang them around the house to create a winter wonderland.

Bake your favorite Christmas cookie!

Use construction paper and markers to create your own wrapping paper.

Use a paper plate to create a wreath to hang on your door.

Use cardboard tissue tubes and construction paper to make Santa and an elf.

Name all of Santa's reindeer!

Gum drops and toothpicks are a great way to make a decorative Christmas tree.

Make edible snowmen out of marshmallows and your favorite candy.

Count all the lights on your Christmas tree!

Turn off the TV and read a Christmas story by the fire.

Make your picture frame out of paper and give it to a parent for Christmas.

Make sure you go to bed early tonight!

Merry Christmas! Today is meant to be spent with loved ones! Make sure to thank everyone for your gifts.

- Cut along the dashed lines on page 1. DO NOT cut the solid lines.
- Tape or glue page 1 to the front of page 2.

Make a Mini Christmas Stocking!

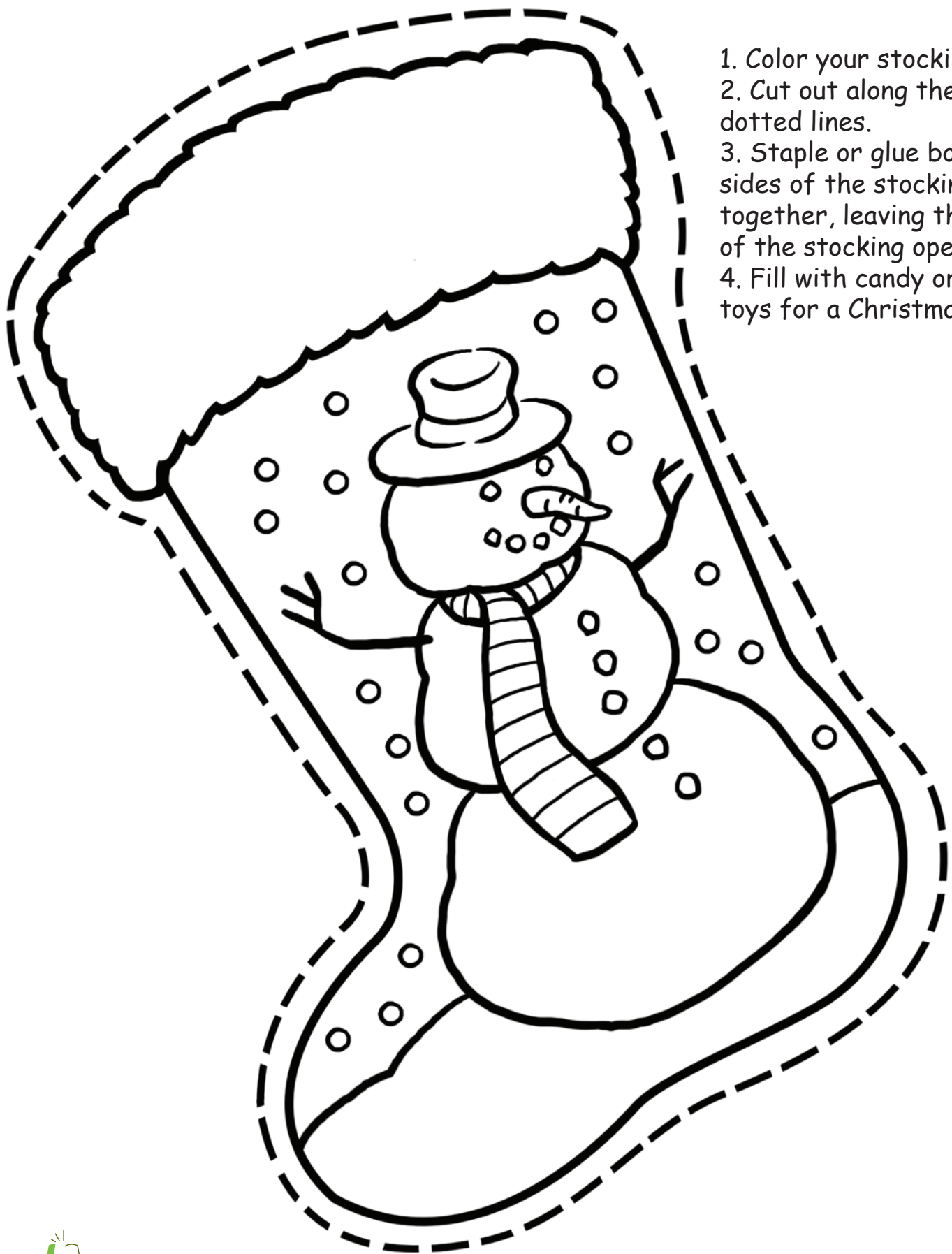

1. Color your stocking.
2. Cut out along the dotted lines.
3. Staple or glue both sides of the stocking together, leaving the top of the stocking open.
4. Fill with candy or small toys for a Christmas treat!

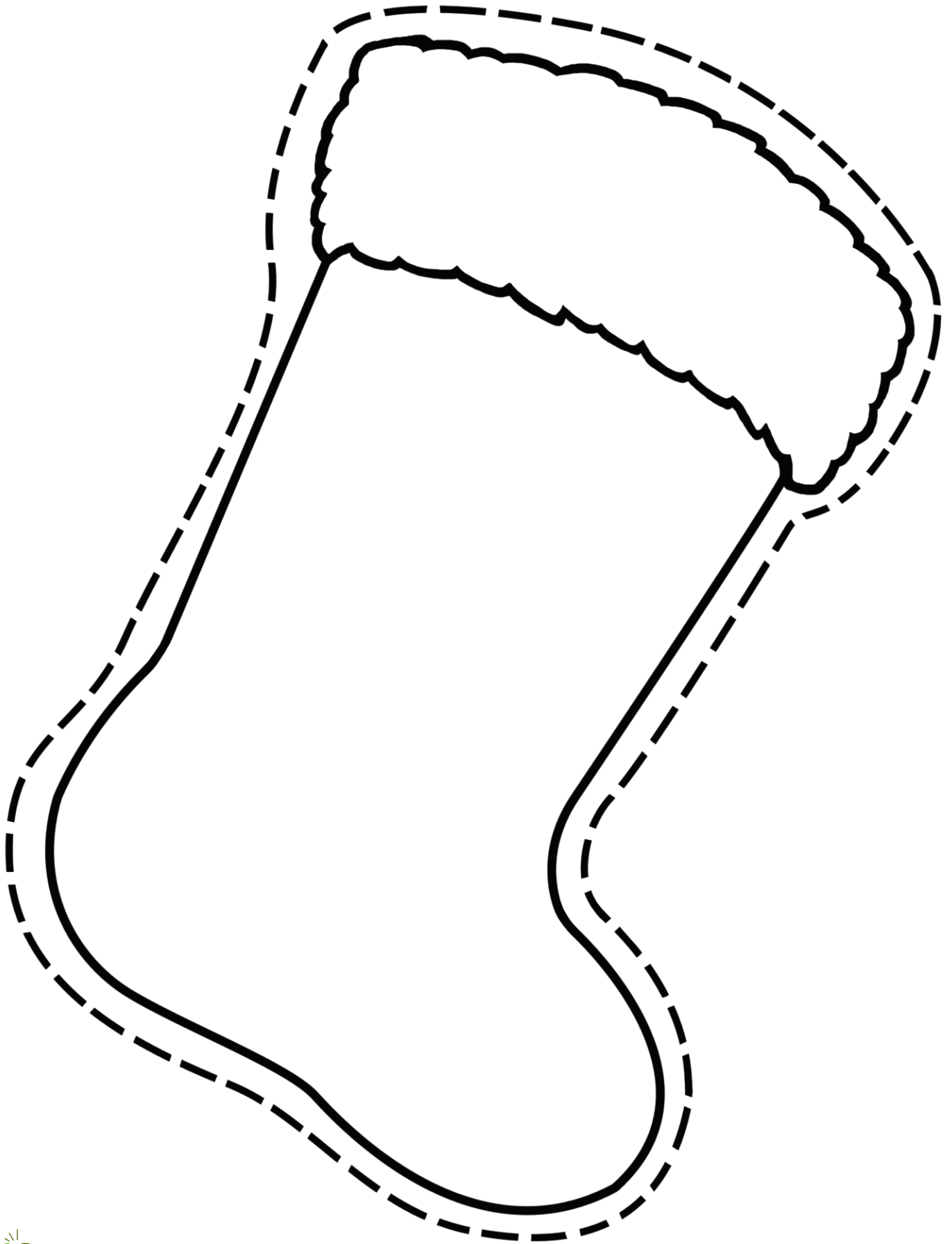

Ski Maze

Help the skier find a fun way through the trees to the bottom of the hill!

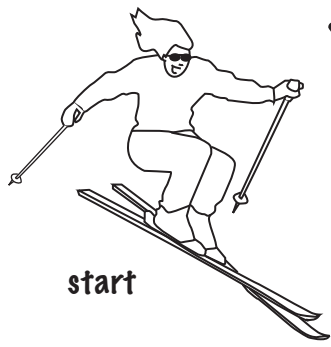

start

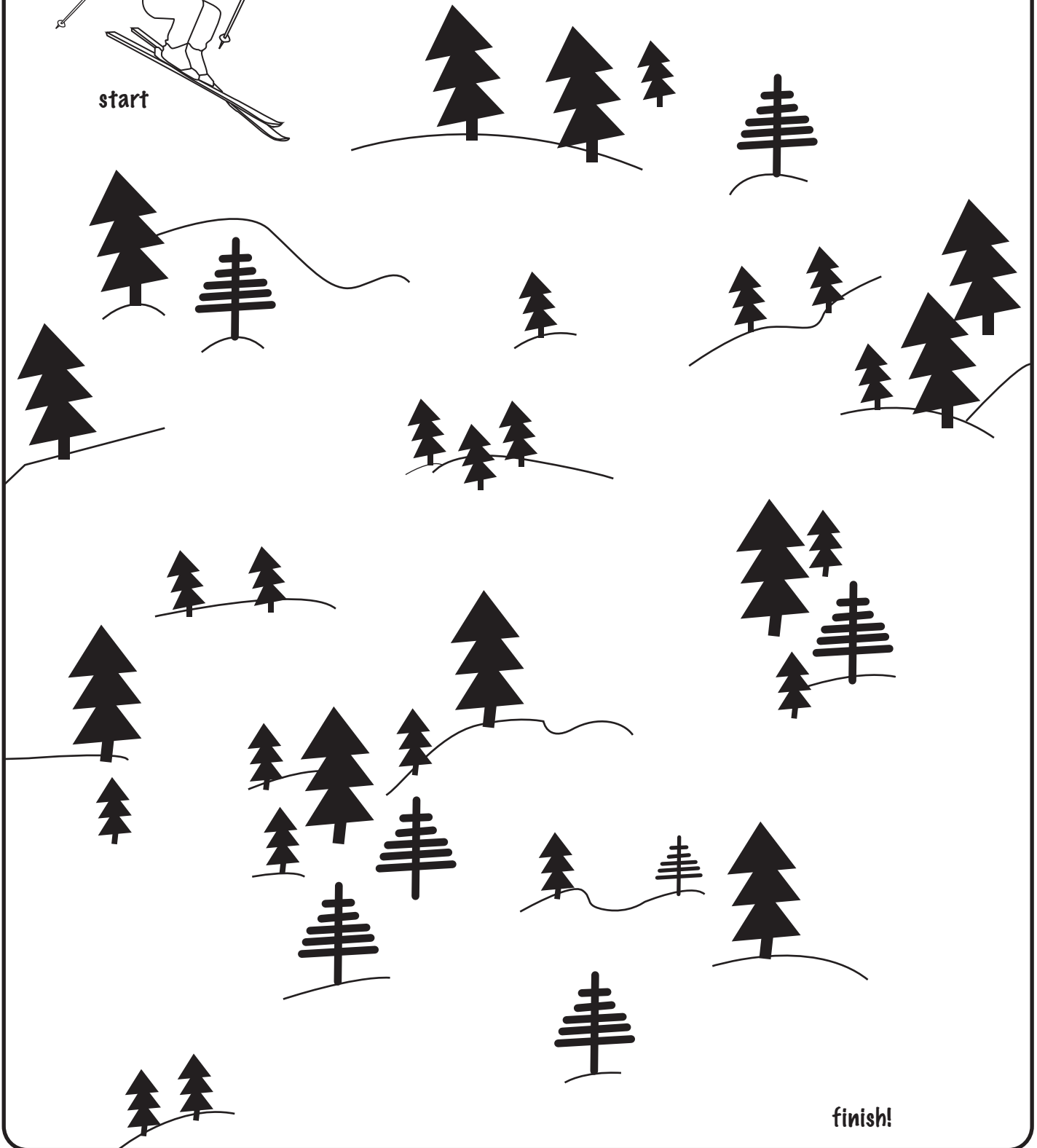

finish!



Play Tic - Tac - Toe With Snowman & Snowflakes



Please note: Game pieces work best when printed on thicker paper.

Tic-Tac-Toe Markers

Cut out the markers to play Tic-Tac-Toe with a friend!
Please note: Game pieces work best when printed on thicker paper.



Markers

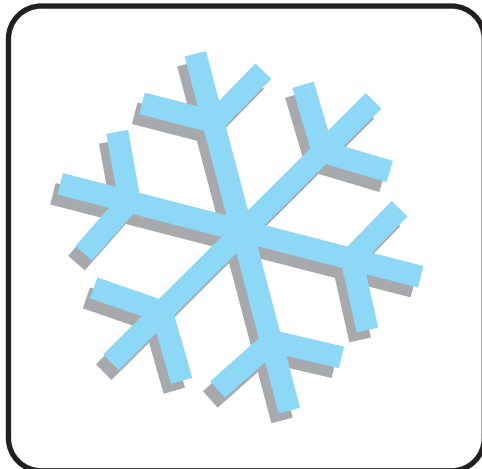



Holiday CARDS

PAGE
ONE

After coloring, cut the cards roughly out from the page. Fold on the dotted lines, then cut out the shapes. Make sure not to cut the edges holding the cards together! Next, write a message inside and sign your name!

The second page has an envelope to cut and assemble.
Ask a grown-up for help with this project if needed!

This project
works best printed
on thicker paper!



Fold
on the
dotted
lines!

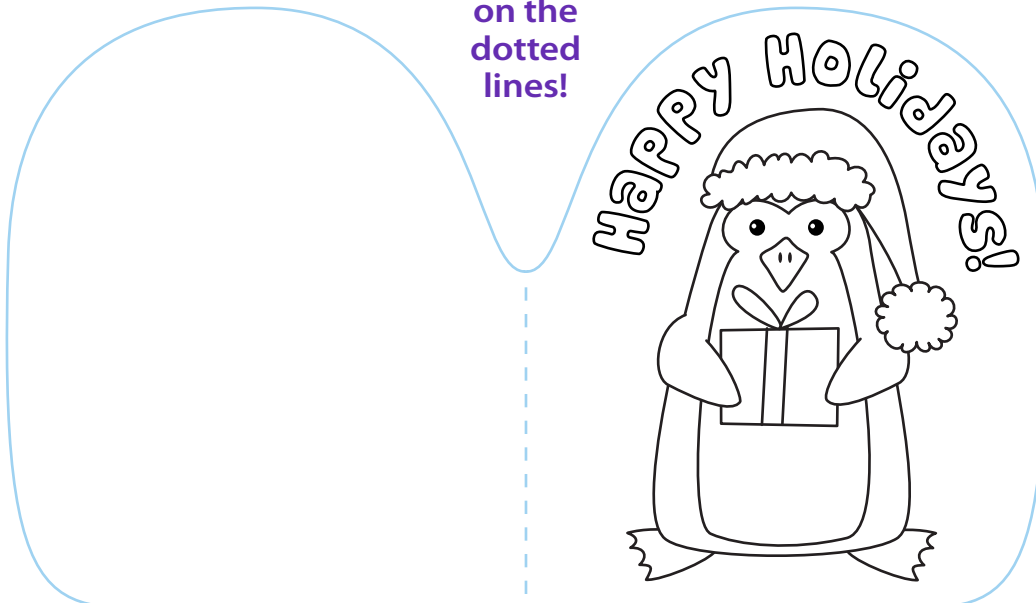

Make an Envelope for Your Holiday Card!

1 Fold the sides in and tape them together.

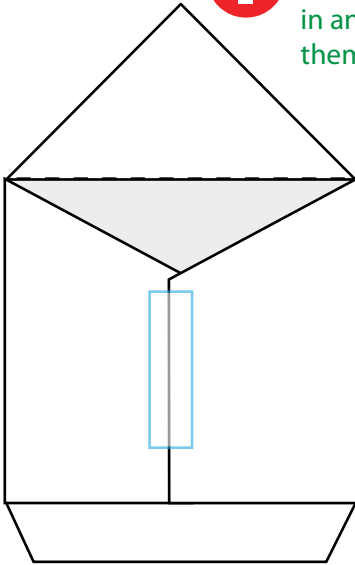

2 Next, fold up the bottom flap and tape.

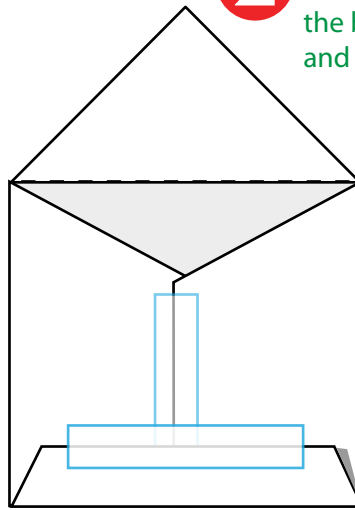

3 Turn over & decorate!



Fold on the dotted lines.

Print on **thicker paper** for best results.

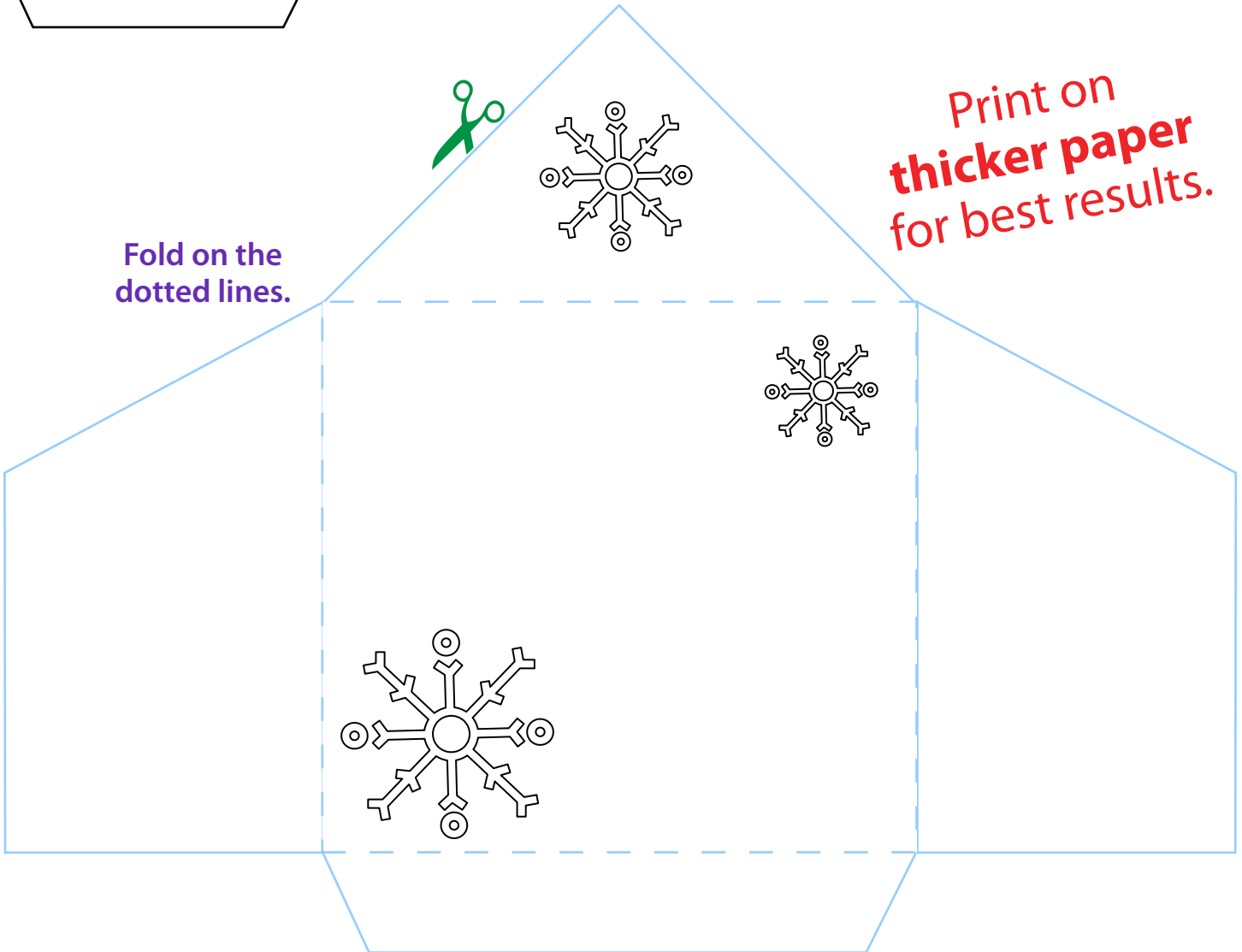

Christmas Village

1. Color in the buildings and cut them out along the bold lines.
2. Cut out the stand.
3. Fold the outer flaps of the stand along the dotted lines.
4. With the flaps facing out, attach the stand to the back of the building with a piece of tape or glue.
5. When the tape is set or the glue dries, you can set it up in a window or on a table for a festive touch!

You can use small toys or dolls to live in your holiday village, and make snow with small bits of scrap paper or cotton balls.

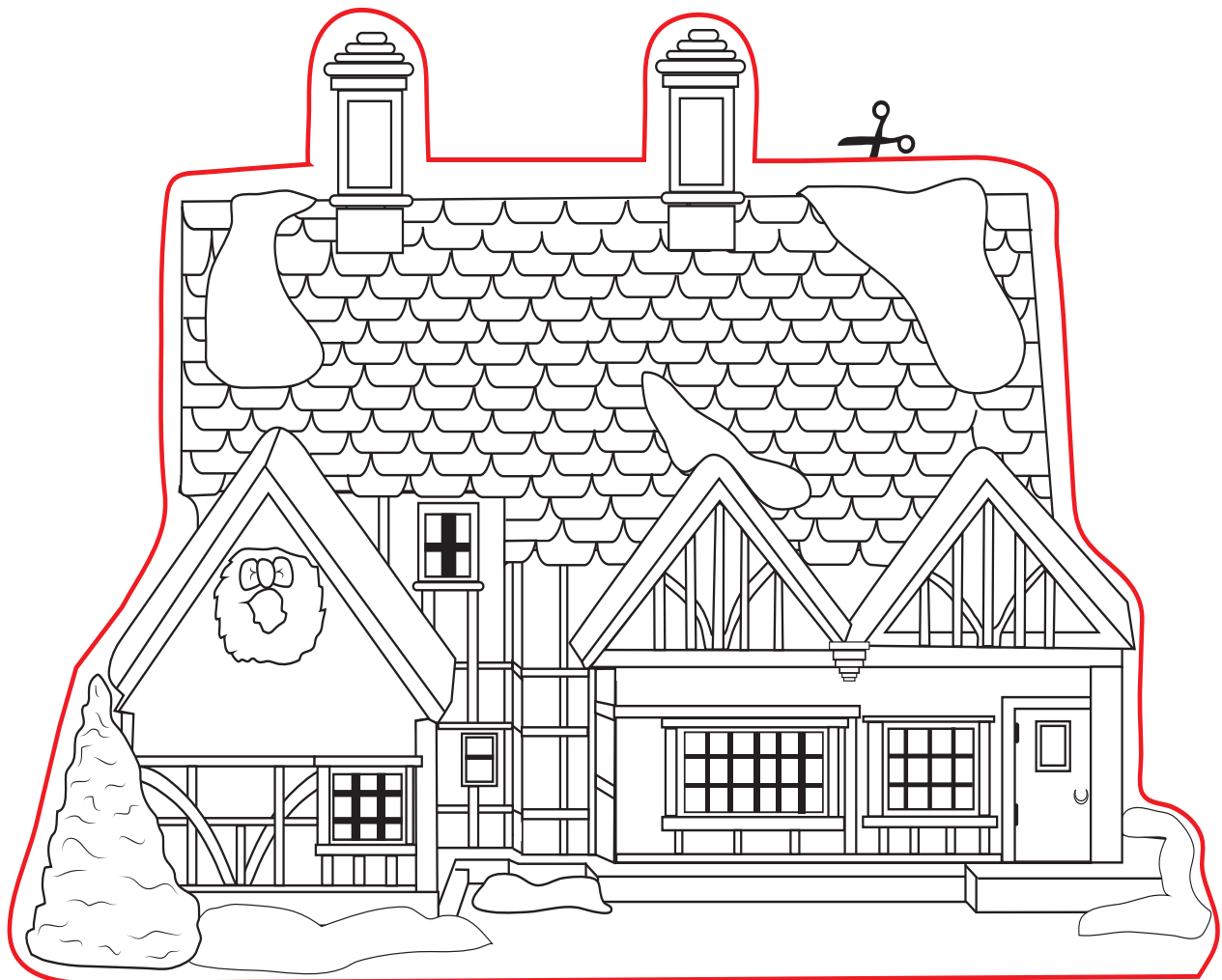
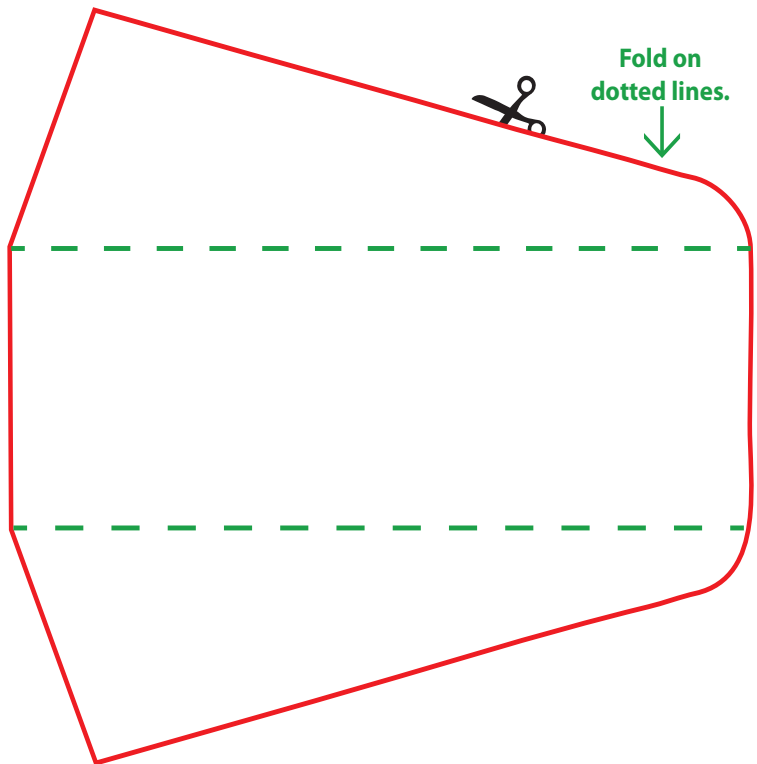
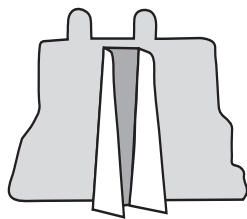

Christmas Village

1. Color in the buildings and cut them out along the bold lines.
2. Cut out the stand.
3. Fold the outer flaps of the stand along the dotted lines.
4. With the flaps facing out, attach the stand to the back of the building with a piece of tape or glue.
5. When the tape is set or the glue dries, you can set it up in a window or on a table for a festive touch!

You can use small toys or dolls to live in your holiday village, and make snow with small bits of scrap paper or cotton balls.

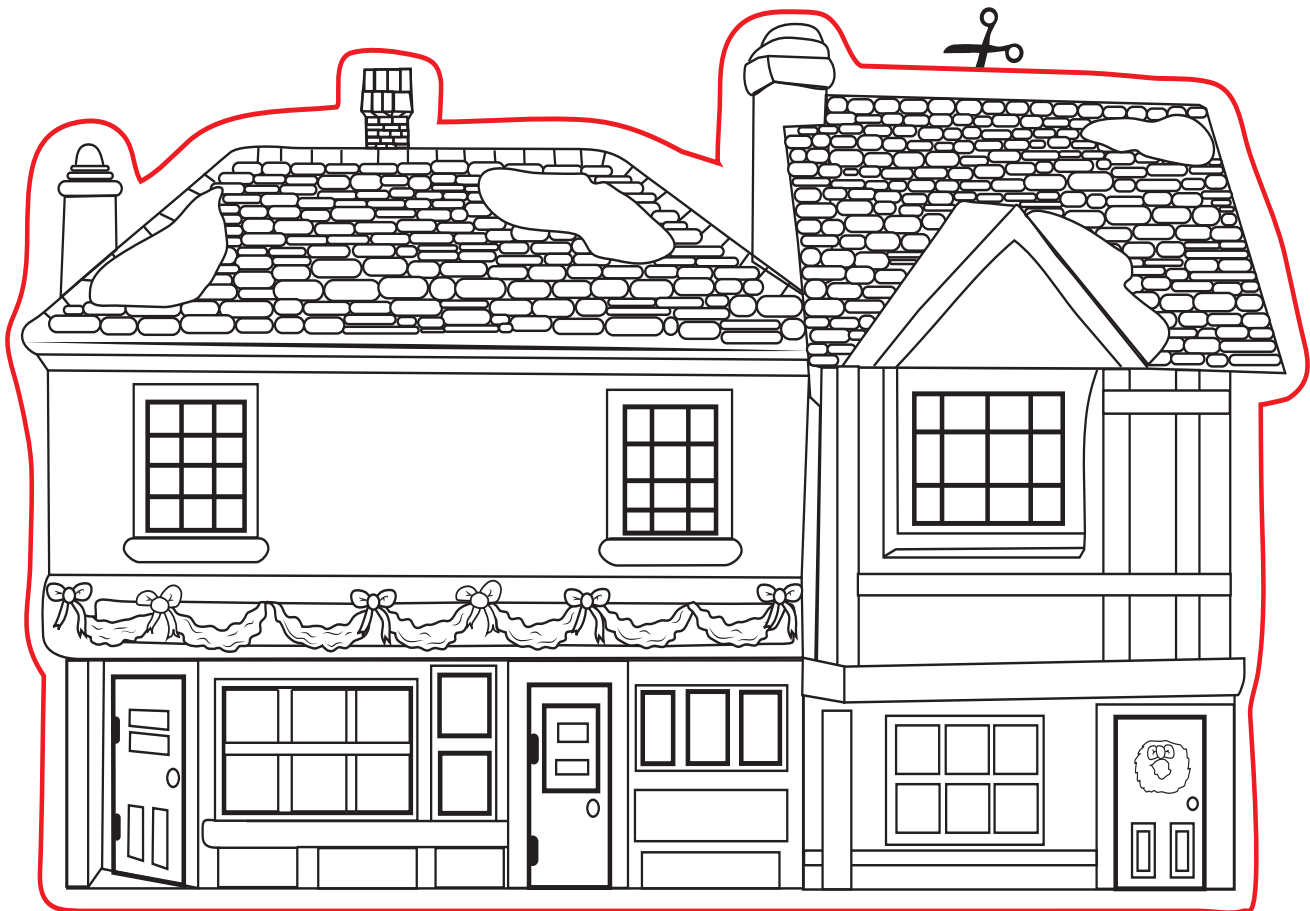
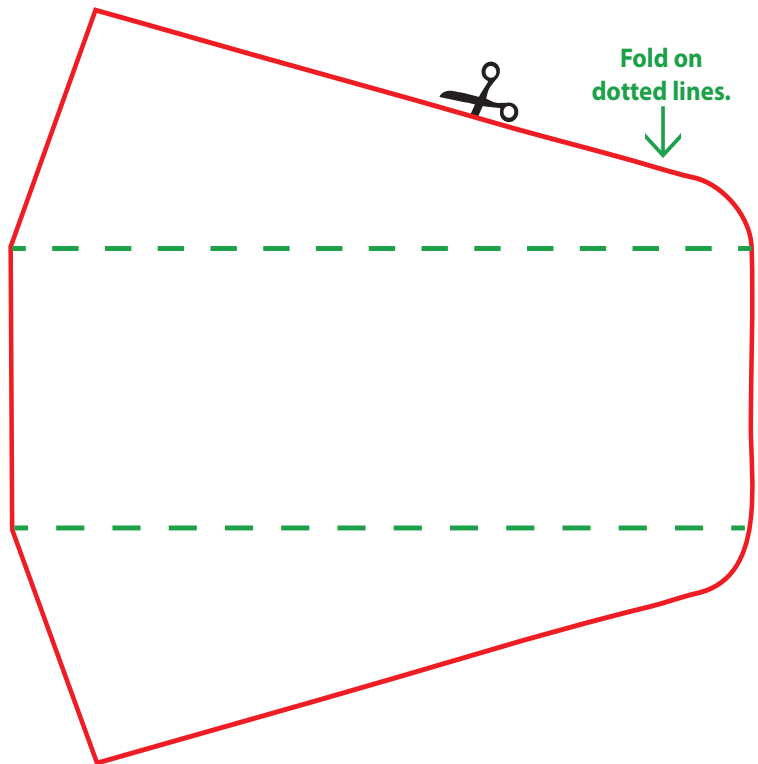
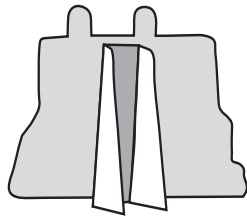

Christmas Village

1. Color in the buildings and cut them out along the bold lines.
2. Cut out the stand.
3. Fold the outer flaps of the stand along the dotted lines.
4. With the flaps facing out, attach the stand to the back of the building with a piece of tape or glue.
5. When the tape is set or the glue dries, you can set it up in a window or on a table for a festive touch!

You can use small toys or dolls to live in your holiday village, and make snow with small bits of scrap paper or cotton balls.

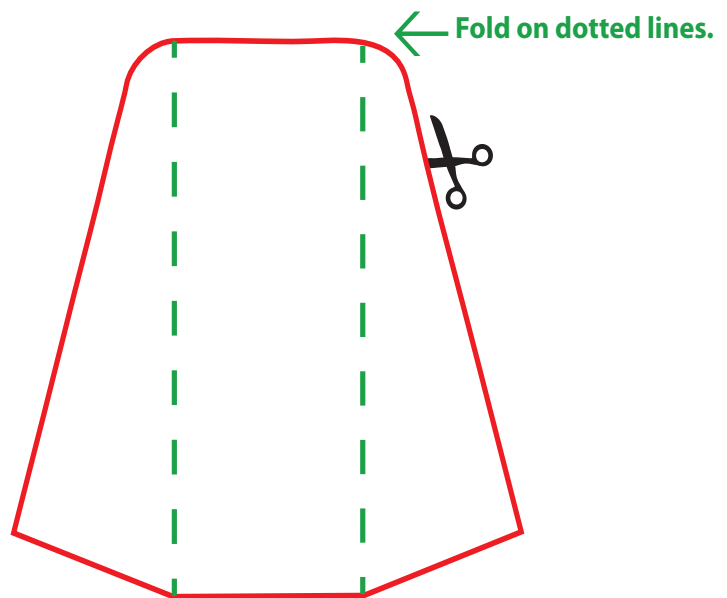
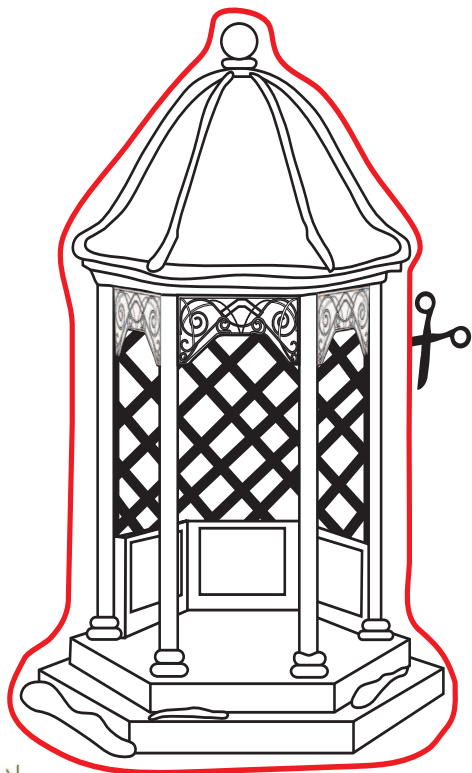
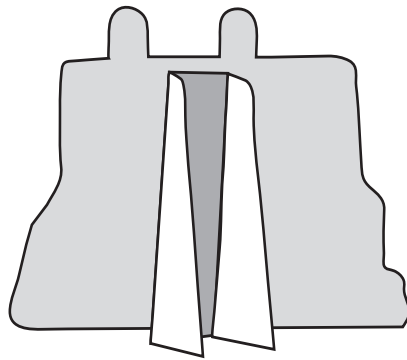

Christmas Village

1. Color in the buildings and cut them out along the bold lines.
2. Cut out the stand.
3. Fold the outer flaps of the stand along the dotted lines.
4. With the flaps facing out, attach the stand to the back of the building with a piece of tape or glue.
5. When the tape is set or the glue dries, you can set it up in a window or on a table for a festive touch!

You can use small toys or dolls to live in your holiday village, and make snow with small bits of scrap paper or cotton balls.

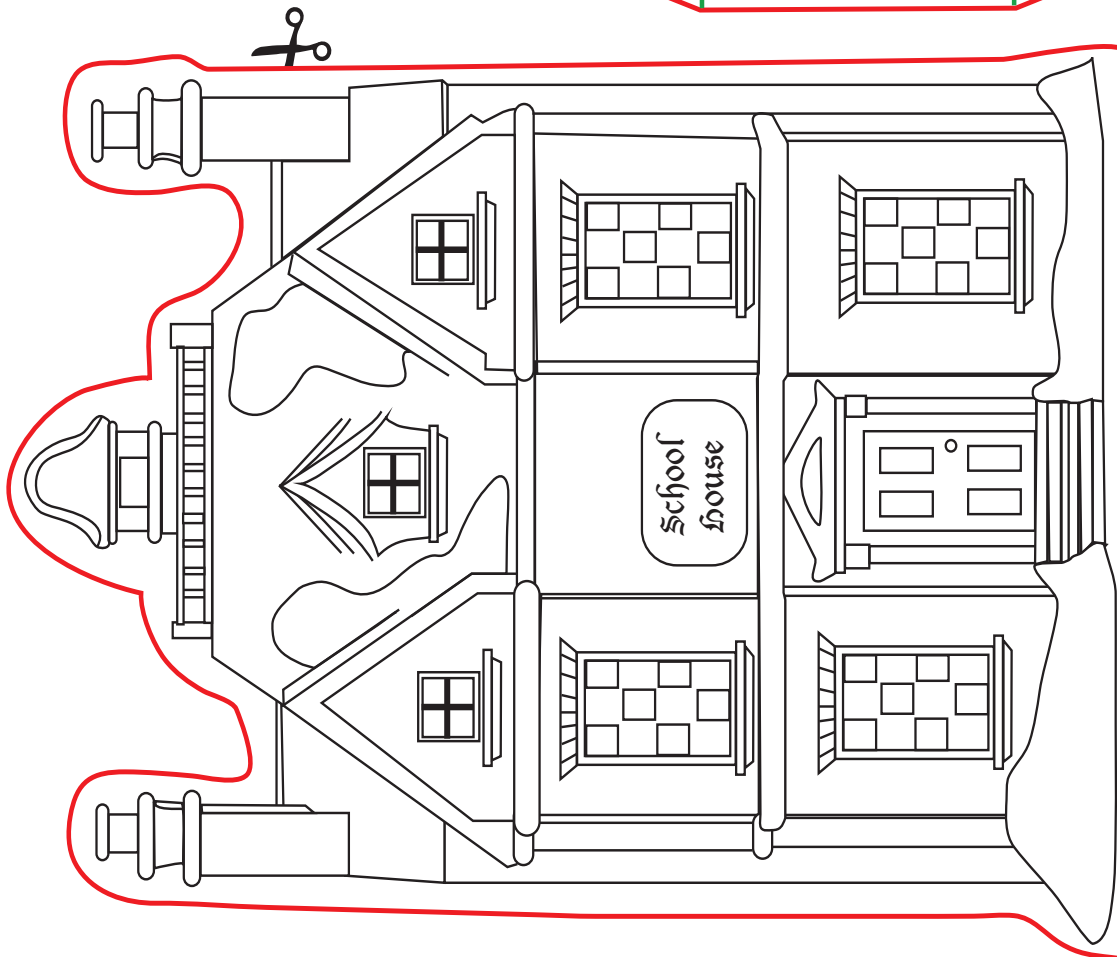
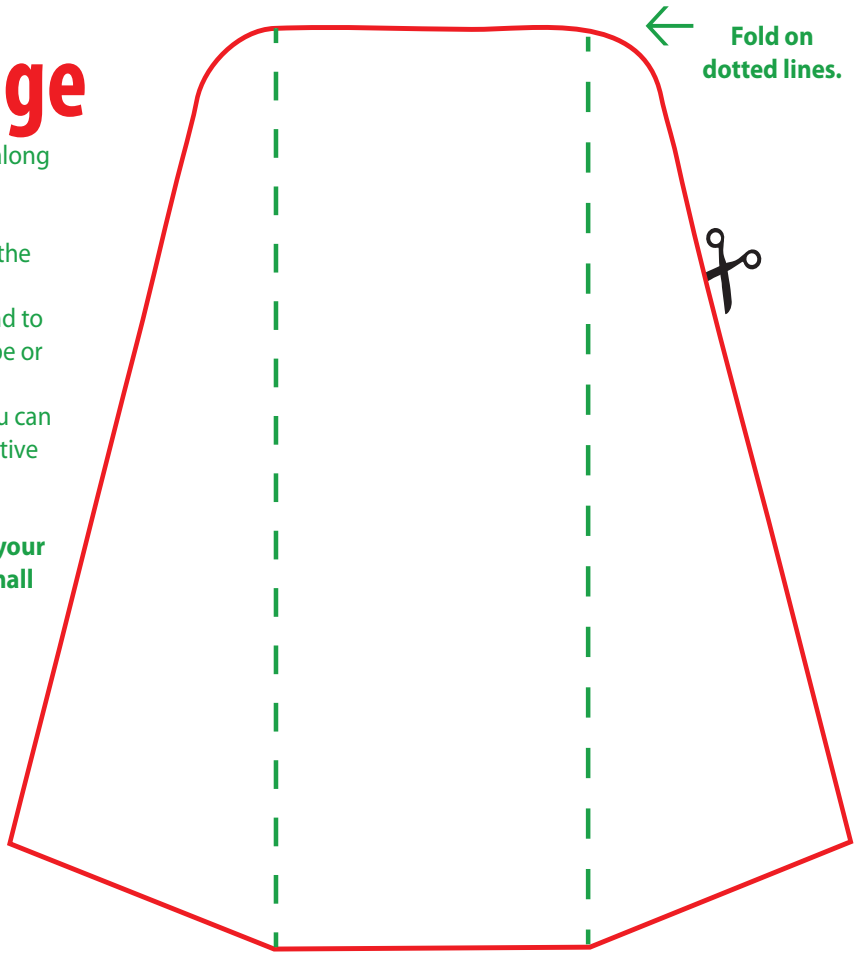
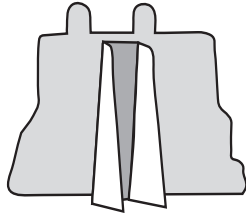

Christmas Village

1. Color in the buildings and cut them out along the bold lines.
2. Cut out the stand.
3. Fold the outer flaps of the stand along the dotted lines.
4. With the flaps facing out, attach the stand to the back of the building with a piece of tape or glue.
5. When the tape is set or the glue dries, you can set it up in a window or on a table for a festive touch!

You can use small toys or dolls to live in your holiday village, and make snow with small bits of scrap paper or cotton balls.

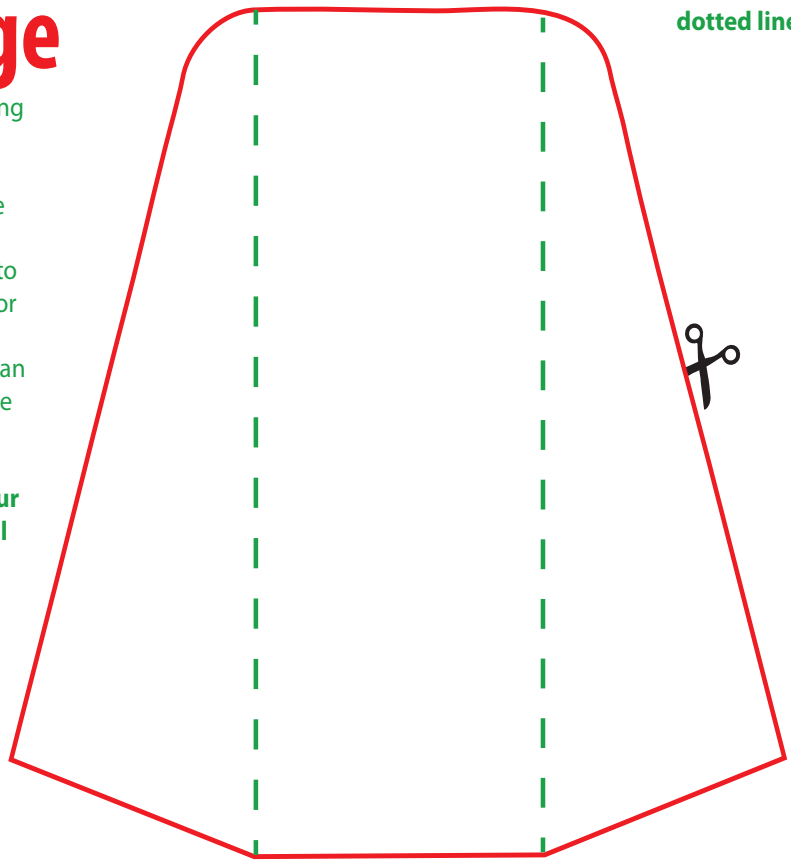
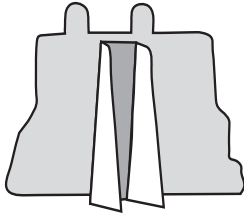

← Fold on dotted lines.



Christmas Village

1. Color in the buildings and cut them out along the bold lines.
2. Cut out the stand.
3. Fold the outer flaps of the stand along the dotted lines.
4. With the flaps facing out, attach the stand to the back of the building with a piece of tape or glue.
5. When the tape is set or the glue dries, you can set it up in a window or on a table for a festive touch!

You can use small toys or dolls to live in your holiday village, and make snow with small bits of scrap paper or cotton balls.

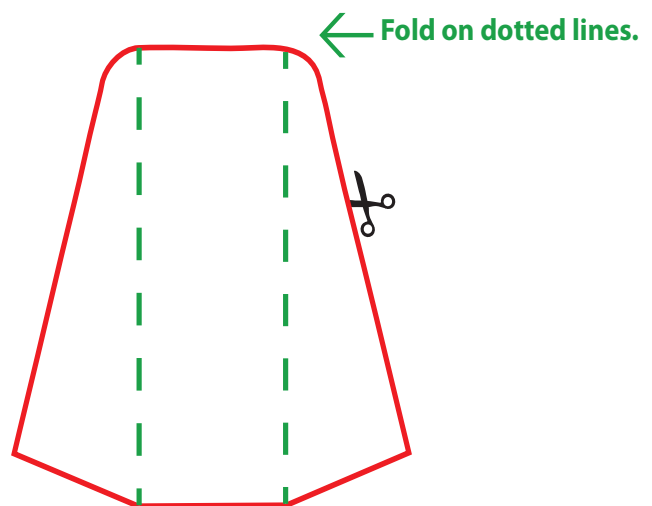
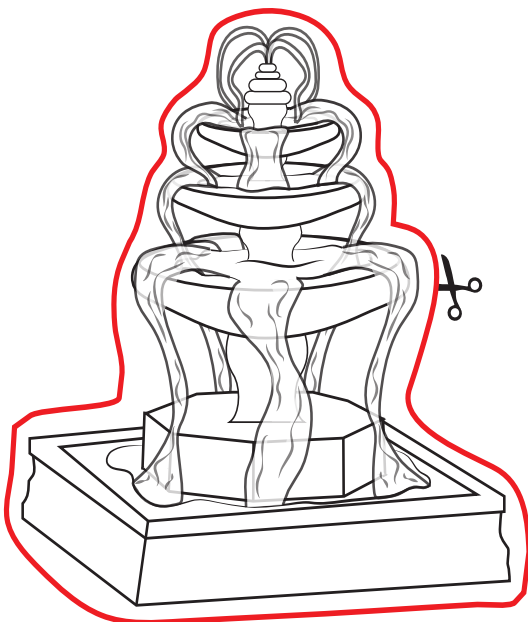
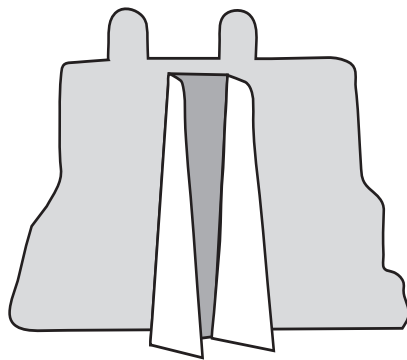

Make your own *New Year's Eve party hat!*

1. Color in the pictures.
2. Cut out your party hat.
3. Curl the hat into a cone shape and tape or glue the tab underneath.
4. Use a hole punch or pencil to punch out the holes.

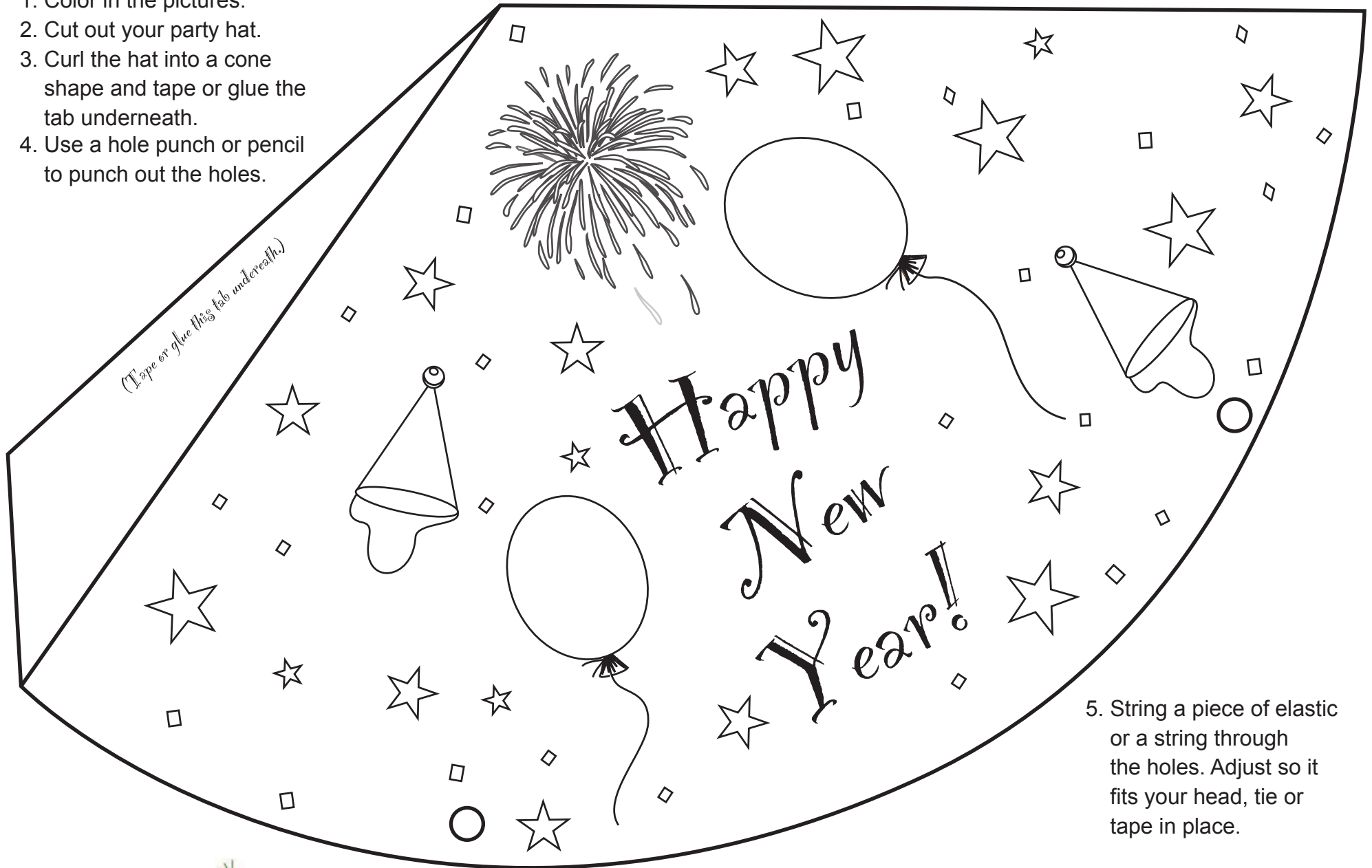

5. String a piece of elastic or a string through the holes. Adjust so it fits your head, tie or tape in place.



My New Year's Resolutions

This year I will...

1. _____

2. _____

3. _____

4. _____

5. _____

Great job!

is an Education.com writing superstar

